



PRODUCT DATA SHEET

MX75F-3SF - 3" DIGITAL FLOW METER WITH ER DISPLAY

The MX Series 3" DIGITAL FLOW METER are suitable for flows between 20 – 733 L/min (5.28 - 193.64 GPM), providing highly accurate flow measurement performance. The MX Series offers $\pm 0.5\%$ accuracy of true reading in a compact footprint, requiring no flow conditioning and with high pressure and temperature capabilities.

Key features include:

- Aluminium (6061) construction
- FKM (Viton) seals
- Maximum flow rate 733 L/min / 193.64 GPM
- Accuracy of $\pm 0.5\%$ of reading
- Exceptional repeatability of $\pm 0.03\%$
- Temperature up to 120 °C / 248 °F
- 1 point factory calibration as standard, with additional points upon request

SPECIFICATIONS



MX75F-3SF
Digital Register

ER	MX75F-3SF		
Material of construction			
Meter Body	Aluminium (6061)		
Rotor	Aluminium (6061)		
Seals	FKM (Viton)		
Design Specifications			
Process Connections	3" ANSI 150 Flange		
Technical Specifications	min	max	
Flow rate	60	600	L/min
< 5cPr	15.85	158.50	GPM
> 5cP	20	733	L/min
	5.28	193.64	GPM
Non lubricating fluids	-	733	L/min
	-	193.64	GPM
Operating Temperature Range**	-40	120	°C
	-40	248	°F
Accuracy ($\pm\%$)	$\pm 0.5\%$		
Repeatability ($\pm\%$)	$\pm 0.03\%$		
Nominal K-Factor	2.58 Pulses/Litre		
	9.77 Pulses/Gallon		

OUTPUT TYPE



ER DISPLAY

	ER [LCD 17mm display]
Construction	Aluminium
IP Rating	IP67
Temp	Min: -40 Max: 80 °C Min: -40 Max: 176 °F
EX Approvals	- Please refer to instruction manual and certification documentation for product appropriate certification information
Display	
Digit size (upper/lower)	17mm/8mm
Accumulated total	✓
Resettable total	✓
Preset total	✗
Flow rate	✓
Outputs	
4-20 mA (passive)	✗
Pulse/Transistor Output	✗
Flow Alarm	✗
Batch Control output	✗



PRODUCT DATA SHEET

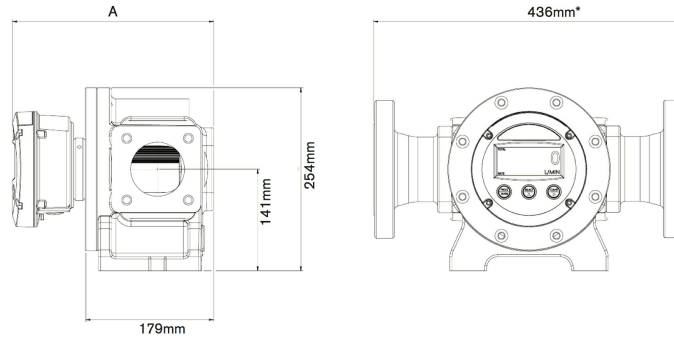

PULSER AND DISPLAY HEIGHT - A

OUTPUT A,I,J,K
PULSER - Standard

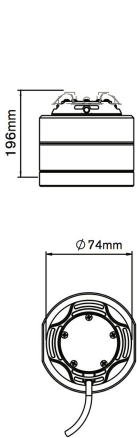

OUTPUT B
PULSER - Exia

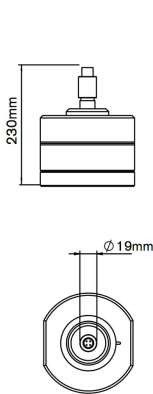

OUTPUT C
PULSER - EXd

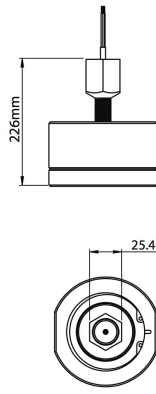

OUTPUT N
PULSER - Exia

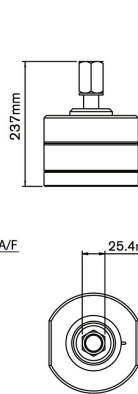

OUTPUT T
PULSER - High Temp.

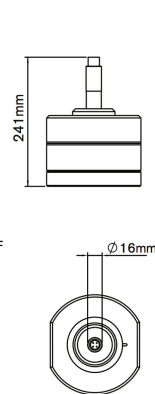

OUTPUT D,E
DISPLAY - LCD 12mm

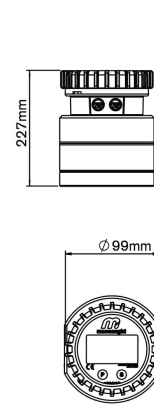

OUTPUT F,G,H DISPLAY
- LCD 17mm

